







Precision Stainless, Inc.



STANDARD AND CUSTOM STAINLESS STEEL TUBE FITTINGS

I-LINE FITTINGS

CONTENTS		Bevel Seat Fittings
		BPE Fittings
		Clamp Fittings
		I-Line Fittings
		John Perry Fittings
		Sanitary Butt weld Fittings
		Tube O.D. Fittings

2CI

90° Female I-Line Elbow

304 Item Number	Tube O.D.	A	316L Item Number
2CI-0100-7-4	1	2.281	2CI-0100-7-6
2CI-0150-7-4	1.5	3.182	2CI-0150-7-6
2CI-0200-7-4	2	4.031	2CI-0200-7-6
2CI-0250-7-4	2.5	4.906	2CI-0250-7-6
2CI-0300-7-4	3	5.718	2CI-0300-7-6
2CI-0400-7-4	4	7.343	2CI-0400-7-6

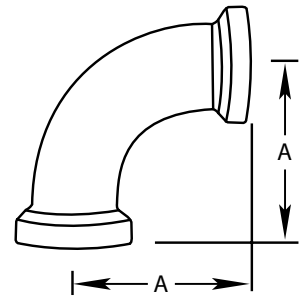

2EI

90° Male I-Line Elbow

304 Item Number	Tube O.D.	A	316L Item Number
2EI-0100-7-4	1	2.093	2EI-0100-7-6
2EI-0150-7-4	1.5	3.000	2EI-0150-7-6
2EI-0200-7-4	2	3.781	2EI-0200-7-6
2EI-0250-7-4	2.5	4.593	2EI-0250-7-6
2EI-0300-7-4	3	5.406	2EI-0300-7-6
2EI-0400-7-4	4	7.031	2EI-0400-7-6

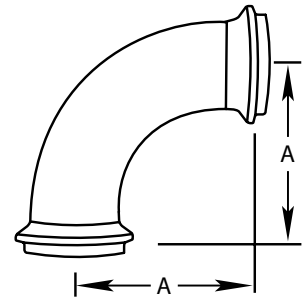

2FI

90° Female I-Line x Male I-Line Elbow

304 Item Number	Tube O.D.	A	B	316L Item Number
2FI-0100-4	1	2.281	2.093	2FI-0100-6
2FI-0150-4	1.5	3.187	3.000	2FI-0150-6
2FI-0200-4	2	4.031	3.781	2FI-0200-6
2FI-0250-4	2.5	4.906	4.593	2FI-0250-6
2FI-0300-4	3	5.718	5.406	2FI-0300-6
2FI-0400-4	4	7.343	7.031	2FI-0400-6

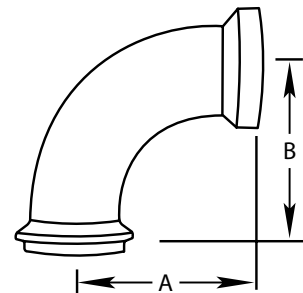

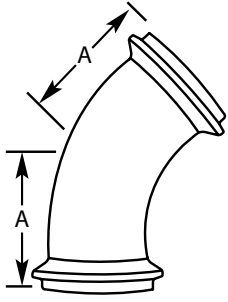

2HI

45° Male I-Line Elbow

304 Item Number	Tube O.D.	A	316L Item Number
2HI-0100-7-4	1	1.218	2HI-0100-7-6
2HI-0150-7-4	1.5	1.687	2HI-0150-7-6
2HI-0200-7-4	2	2.031	2HI-0200-7-6
2HI-0250-7-4	2.5	2.406	2HI-0250-7-6
2HI-0300-7-4	3	2.781	2HI-0300-7-6
2HI-0400-7-4	4	3.531	2HI-0400-7-6

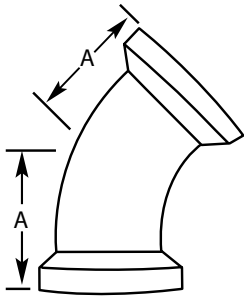

2KI

45° Female I-Line Elbow

304 Item Number	Tube O.D.	A	316L Item Number
2KI-0100-7-4	1	1.406	2KI-0100-7-6
2KI-0150-7-4	1.5	1.875	2KI-0150-7-6
2KI-0200-7-4	2	2.281	2KI-0200-7-6
2KI-0250-7-4	2.5	2.718	2KI-0250-7-6
2KI-0300-7-4	3	3.093	2KI-0300-7-6
2KI-0400-7-4	4	3.843	2KI-0400-7-6

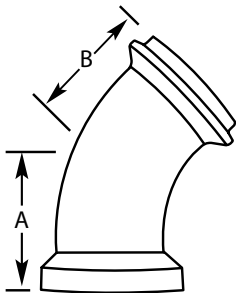

2PI

45° Female I-Line x Male I-Line Elbow

304 Item Number	Tube O.D.	A	B	316L Item Number
2PI-0100-7-4	1	1.406	1.218	2PI-0100-7-6
2PI-0150-7-4	1.5	1.875	1.687	2PI-0150-7-6
2PI-0200-7-4	2	2.281	2.031	2PI-0200-7-6
2PI-0250-7-4	2.5	2.718	2.406	2PI-0250-7-6
2PI-0300-7-4	3	3.093	2.781	2PI-0300-7-6
2PI-0400-7-4	4	3.843	3.531	2PI-0400-7-6

7I

Female I-Line Tee

304 Item Number	Tube O.D.	A	316L Item Number
7I-0100-7-4	1	1.875	7I-0100-7-6
7I-0150-7-4	1.5	2.593	7I-0150-7-6
7I-0200-7-4	2	3.062	7I-0200-7-6
7I-0250-7-4	2.5	3.468	7I-0250-7-6
7I-0300-7-4	3	3.812	7I-0300-7-6
7I-0400-7-4	4	4.968	7I-0400-7-6

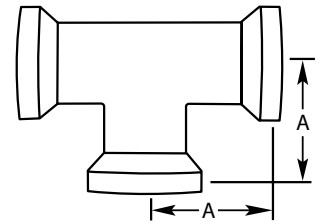

7AI

Female I-Line Run x Male I-Line Branch Tee

304 Item Number	Tube O.D.	A	B	316L Item Number
7AI-0100-7-4	1	1.687	1.875	7AI-0100-7-6
7AI-0150-7-4	1.5	2.406	2.593	7AI-0150-7-6
7AI-0200-7-4	2	2.812	3.062	7AI-0200-7-6
7AI-0250-7-4	2.5	3.156	3.468	7AI-0250-7-6
7AI-0300-7-4	3	3.500	3.812	7AI-0300-7-6
7AI-0400-7-4	4	4.656	4.968	7AI-0400-7-6

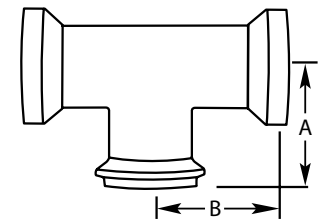

7BI

Male I-Line x Female I-Line Run x Female I-Line Branch Tee

304 Item Number	Tube O.D.	A	B	316L Item Number
7BI-0100-7-4	1	1.875	1.687	7BI-0100-7-6
7BI-0150-7-4	1.5	2.593	2.406	7BI-0150-7-6
7BI-0200-7-4	2	3.062	2.812	7BI-0200-7-6
7BI-0250-7-4	2.5	3.468	3.156	7BI-0250-7-6
7BI-0300-7-4	3	3.812	3.500	7BI-0300-7-6
7BI-0400-7-4	4	4.968	4.656	7BI-0400-7-6

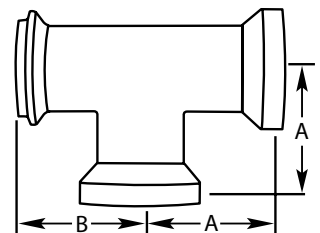

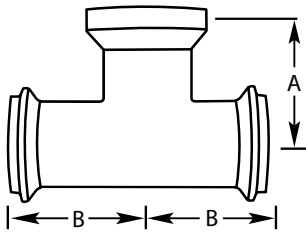

7EI

Male I-Line Run x Female I-Line Branch Tee

304 Item Number	Tube O.D.	A	B	316L Item Number
7EI-0100-7-4	1	1.875	1.687	7EI-0100-7-6
7EI-0150-7-4	1.5	2.593	2.406	7EI-0150-7-6
7EI-0200-7-4	2	3.062	2.812	7EI-0200-7-6
7EI-0250-7-4	2.5	3.468	3.156	7EI-0250-7-6
7EI-0300-7-4	3	3.812	3.500	7EI-0300-7-6
7EI-0400-7-4	4	4.968	4.656	7EI-0400-7-6

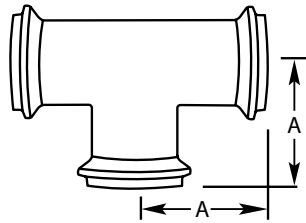

7HI

Male I-Line Tee

304 Item Number	Tube O.D.	A	316L Item Number
7HI-0100-7-4	1	1.687	7HI-0100-7-6
7HI-0150-7-4	1.5	2.406	7HI-0150-7-6
7HI-0200-7-4	2	2.812	7HI-0200-7-6
7HI-0250-7-4	2.5	3.156	7HI-0250-7-6
7HI-0300-7-4	3	3.500	7HI-0300-7-6
7HI-0400-7-4	4	4.656	7HI-0400-7-6

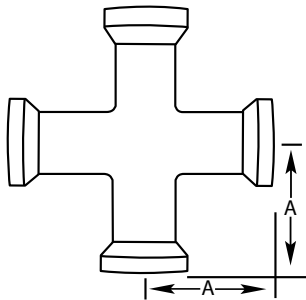

9I

Female I-Line Cross

304 Item Number	Tube O.D.	A	316L Item Number
9I-0100-7-4	1	1.875	9I-0100-7-6
9I-0150-7-4	1.5	2.593	9I-0150-7-6
9I-0200-7-4	2	3.062	9I-0200-7-6
9I-0250-7-4	2.5	3.468	9I-0250-7-6
9I-0300-7-4	3	3.811	9I-0300-7-6
9I-0400-7-4	4	4.968	9I-0400-7-6

14WI

Short Male I-Line Ferrule

304 Item Number	Tube O.D.	A	316L Item Number
14WI-0100-4	1	0.593	14WI-0100-6
14WI-0150-4	1.5	0.750	14WI-0150-6
14WI-0200-4	2	0.781	14WI-0200-6
14WI-0250-4	2.5	0.843	14WI-0250-6
14WI-0300-4	3	0.906	14WI-0300-6
14WI-0400-4	4	1.031	14WI-0400-6

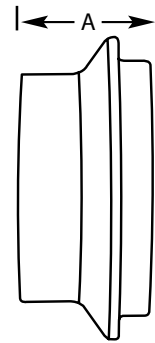

14WLI

Long Male I-Line Ferrule

304 Item Number	Tube O.D.	A	316L Item Number
14WLI-0100-4	1	1.563	14WLI-0100-6
14WLI-0150-4	1.5	1.843	14WLI-0150-6
14WLI-0200-4	2	2.062	14WLI-0200-6
14WLI-0250-4	2.5	2.187	14WLI-0250-6
14WLI-0300-4	3	2.375	14WLI-0300-6
14WLI-0400-4	4	2.687	14WLI-0400-6

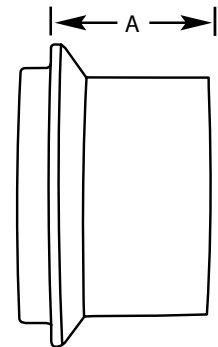

14WHI

Heavy Wall Male I-Line Ferrule

304 Item Number	Tube O.D.	A	B	C	316L Item Number
14WHI-0100-4	1	1.625	1.160	0.870	14WHI-0100-6
14WHI-0150-4	1.5	1.625	1.687	1.370	14WHI-0150-6
14WHI-0200-4	2	1.750	2.250	1.870	14WHI-0200-6
14WHI-0250-4	2.5	1.750	2.708	2.370	14WHI-0250-6
14WHI-0300-4	3	1.812	3.313	2.870	14WHI-0300-6
14WHI-0400-4	4	2.125	4.250	3.834	14WHI-0400-6

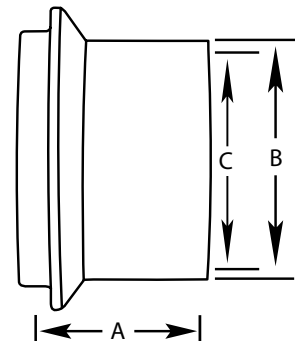

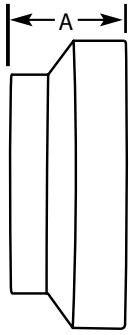

15WI

Short Female I-Line Ferrule

304 Item Number	Tube O.D.	A	316L Item Number
15WI-0100-4	1	0.781	15WI-0100-6
15WI-0150-4	1.5	0.937	15WI-0150-6
15WI-0200-4	2	1.031	15WI-0200-6
15WI-0250-4	2.5	1.156	15WI-0250-6
15WI-0300-4	3	1.218	15WI-0300-6
15WI-0400-4	4	1.343	15WI-0400-6

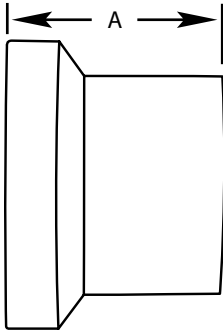

15WLI

Long Female I-Line Ferrule

304 Item Number	Tube O.D.	A	316L Item Number
15WLI-0100-4	1	1.750	15WLI-0100-6
15WLI-0150-4	1.5	2.031	15WLI-0150-6
15WLI-0200-4	2	2.312	15WLI-0200-6
15WLI-0250-4	2.5	2.500	15WLI-0250-6
15WLI-0300-4	3	2.687	15WLI-0300-6
15WLI-0400-4	4	3.000	15WLI-0400-6

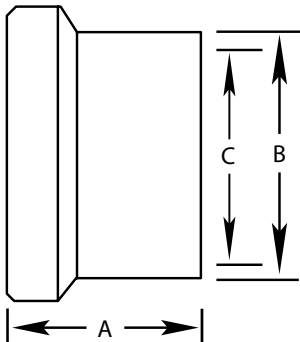

15WHI

Heavy Wall Female I-Line Ferrule

304 Item Number	Tube O.D.	A	B	C	316L Item Number
15WHI-0100-4	1	1.625	1.160	0.870	15WHI-0100-6
15WHI-0150-4	1.5	1.625	1.687	1.370	15WHI-0150-6
15WHI-0200-4	2	1.750	2.250	1.870	15WHI-0200-6
15WHI-0250-4	2.5	1.750	2.708	2.370	15WHI-0250-6
15WHI-0300-4	3	1.812	3.313	2.870	15WHI-0300-6
15WHI-0400-4	4	2.125	4.250	3.834	15WHI-0400-6

16AI-14I

Male I-Line Solid End Cap

304 Item Number	Tube O.D.	A	B	316L Item Number
16AI-14I-0100-4	1	2.000	0.500	16AI-14I-0100-6
16AI-14I-0150-4	1.5	2.000	0.500	16AI-14I-0150-6
16AI-14I-0200-4	2	2.625	0.562	16AI-14I-0200-6
16AI-14I-0250-4	2.5	3.312	0.750	16AI-14I-0250-6
16AI-14I-0300-4	3	3.875	0.750	16AI-14I-0300-6
16AI-14I-0400-4	4	4.875	0.750	16AI-14I-0400-6
16AI-14I-0600-4	6	7.500	0.875	16AI-14I-0600-6

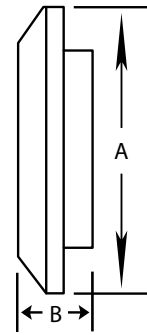

16AI-15I

Female I-Line Solid End Cap

304 Item Number	Tube O.D.	A	B	316L Item Number
16AI-15I-0100-4	1	2.000	0.500	16AI-15I-0100-6
16AI-15I-0150-4	1.5	2.000	0.500	16AI-15I-0150-6
16AI-15I-0200-4	2	2.625	0.687	16AI-15I-0200-6
16AI-15I-0250-4	2.5	3.312	0.750	16AI-15I-0250-6
16AI-15I-0300-4	3	3.875	0.750	16AI-15I-0300-6
16AI-15I-0400-4	4	4.875	0.750	16AI-15I-0400-6
16AI-15I-0600-4	6	7.500	0.750	16AI-15I-0600-6

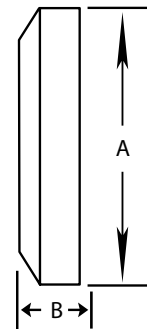

14HRI

Male I-Line Rubber Hose Adapter

304 Item Number	Tube O.D.	A	316L Item Number
14HRI-0100-4	1	3.562	14HRI-0100-6
14HRI-0150-4	1.5	3.750	14HRI-0150-6
14HRI-0200-4	2	3.750	14HRI-0200-6
14HRI-0250-4	2.5	3.812	14HRI-0250-6
14HRI-0300-4	3	3.875	14HRI-0300-6
14HRI-0400-4	4	4.062	14HRI-0400-6

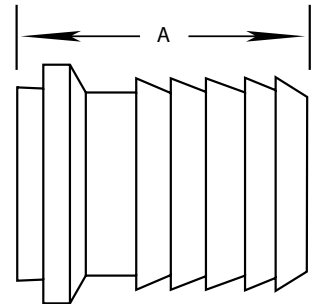

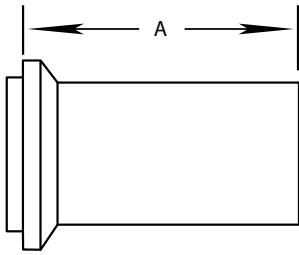

14HTI

Male I-Line Tygon® Hose Adapter

304 Item Number	Tube O.D.	A	316L Item Number
14HTI-0100-4	1 in	4.062	14HTI-0100-6
14HTI-0150-4	1.5 in	4.281	14HTI-0150-6
14HTI-0200-4	2 in	4.500	14HTI-0200-6
14HTI-0250-4	2.5 in	4.812	14HTI-0250-6
14HTI-0300-4	3 in	5.062	14HTI-0300-6
14HTI-0400-4	4 in	5.187	14HTI-0400-6

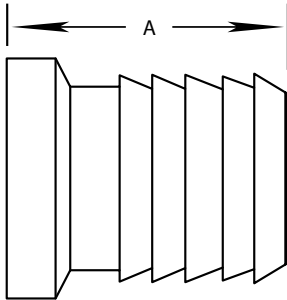

15HRI

Female I-Line Rubber Hose Adapter

304 Item Number	Tube O.D.	A	316L Item Number
15HRI-0100-4	1	3.750	15HRI-0100-6
15HRI-0150-4	1.5	3.937	15HRI-0150-6
15HRI-0200-4	2	4.062	15HRI-0200-6
15HRI-0250-4	2.5	4.125	15HRI-0250-6
15HRI-0300-4	3	4.187	15HRI-0300-6
15HRI-0400-4	4	4.375	15HRI-0400-6

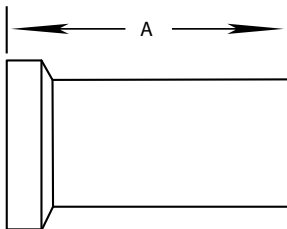

15HTI

Female I-Line Tygon® Hose Adapter

304 Item Number	Tube O.D.	A	316L Item Number
15HTI-0100-4	1 in	4.250	15HTI-0100-6
15HTI-0150-4	1.5 in	4.468	15HTI-0150-6
15HTI-0200-4	2 in	4.750	15HTI-0200-6
15HTI-0250-4	2.5 in	5.125	15HTI-0250-6
15HTI-0300-4	3 in	5.375	15HTI-0300-6
15HTI-0400-4	4 in	5.500	15HTI-0400-6

17-14I-14I

Male I-Line Adapter

304 Item Number	Tube O.D.	A	316L Item Number
17-14I-14I-0100-4	1	1.187	17-14I-14I-0100-6
17-14I-14I-0150-4	1.5	1.500	17-14I-14I-0150-6
17-14I-14I-0200-4	2	1.562	17-14I-14I-0200-6
17-14I-14I-0250-4	2.5	1.687	17-14I-14I-0250-6
17-14I-14I-0300-4	3	1.812	17-14I-14I-0300-6
17-14I-14I-0400-4	4	2.062	17-14I-14I-0400-6

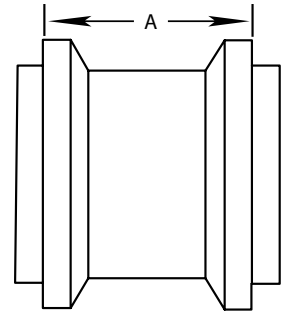

17-14I-15I

Male I-Line x Female I-Line Adapter

304 Item Number	Tube O.D.	A	316L Item Number
17-14I-15I-0100-4	1	1.374	17-14I-15I-0100-6
17-14I-15I-0150-4	1.5	1.687	17-14I-15I-0150-6
17-14I-15I-0200-4	2	1.812	17-14I-15I-0200-6
17-14I-15I-0250-4	2.5	1.937	17-14I-15I-0250-6
17-14I-15I-0300-4	3	2.124	17-14I-15I-0300-6
17-14I-15I-0400-4	4	2.374	17-14I-15I-0400-6
17-14I-15I-0600-4	6	N/A	17-14I-15I-0600-6

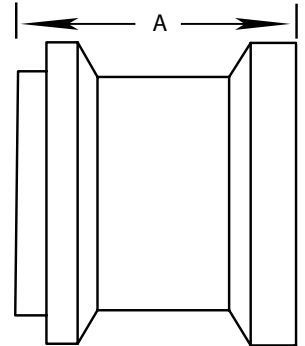

17-15I-15I

Female I-Line Adapter

304 Item Number	Tube O.D.	A	316L Item Number
17-15I-15I-0100-4	1	1.562	17-15I-15I-0100-6
17-15I-15I-0150-4	1.5	1.874	17-15I-15I-0150-6
17-15I-15I-0200-4	2	2.062	17-15I-15I-0200-6
17-15I-15I-0250-4	2.5	2.312	17-15I-15I-0250-6
17-15I-15I-0300-4	3	2.436	17-15I-15I-0300-6
17-15I-15I-0400-4	4	2.686	17-15I-15I-0400-6

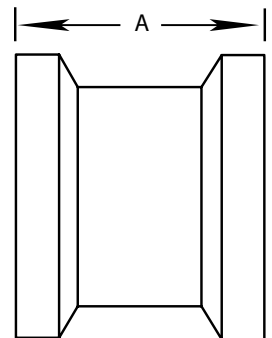

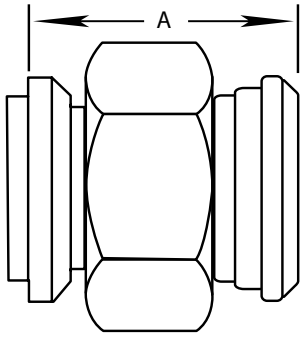

17-14I-14

Male I-Line x Plain Bevel Seat with Hex Nut Adapter

304 Item Number	Tube O.D.	A	316L Item Number
17-14I-14-0100-4	1	1.968	17-14I-14-0100-6
17-14I-14-0150-4	1.5	2.250	17-14I-14-0150-6
17-14I-14-0200-4	2	2.250	17-14I-14-0200-6
17-14I-14-0250-4	2.5	2.562	17-14I-14-0250-6
17-14I-14-0300-4	3	2.687	17-14I-14-0300-6
17-14I-14-0400-4	4	2.812	17-14I-14-0400-6

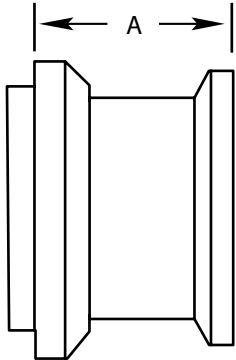

17-14I-14MP

Male I-Line x Clamp Adapter

304 Item Number	Tube O.D.	A	316L Item Number
17-14I-14MP-0100-4	1	1.093	17-14I-14MP-0100-6
17-14I-14MP-0150-4	1.5	1.250	17-14I-14MP-0150-6
17-14I-14MP-0200-4	2	1.250	17-14I-14MP-0200-6
17-14I-14MP-0250-4	2.5	1.312	17-14I-14MP-0250-6
17-14I-14MP-0300-4	3	1.406	17-14I-14MP-0300-6
17-14I-14MP-0400-4	4	1.656	17-14I-14MP-0400-6

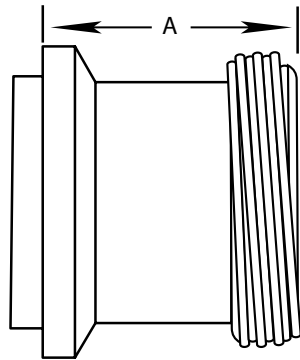

17-14I-15

Male I-Line x Threaded Bevel Seat Adapter

304 Item Number	Tube O.D.	A	316L Item Number
17-14I-15-0100-4	1	1.031	17-14I-15-0100-6
17-14I-15-0150-4	1.5	1.468	17-14I-15-0150-6
17-14I-15-0200-4	2	1.500	17-14I-15-0200-6
17-14I-15-0250-4	2.5	1.686	17-14I-15-0250-6
17-14I-15-0300-4	3	1.812	17-14I-15-0300-6
17-14I-15-0400-4	4	2.062	17-14I-15-0400-6

17-15I-14

Female I-Line x Plain Bevel Seat with Hex Nut Adapter

304 Item Number	Tube O.D.	A	316L Item Number
17-15I-14-0100-4	1	2.156	17-15I-14-0100-6
17-15I-14-0150-4	1.5	2.437	17-15I-14-0150-6
17-15I-14-0200-4	2	2.500	17-15I-14-0200-6
17-15I-14-0250-4	2.5	2.875	17-15I-14-0250-6
17-15I-14-0300-4	3	3.000	17-15I-14-0300-6
17-15I-14-0400-4	4	3.093	17-15I-14-0400-6

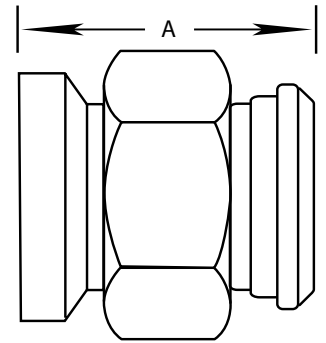

17-15I-14MP

Female I-Line x Clamp Adapter

304 Item Number	Tube O.D.	A	316L Item Number
17-15I-14MP-0100-4	1	1.281	17-15I-14MP-0100-6
17-15I-14MP-0150-4	1.5	1.437	17-15I-14MP-0150-6
17-15I-14MP-0200-4	2	1.500	17-15I-14MP-0200-6
17-15I-14MP-0250-4	2.5	1.625	17-15I-14MP-0250-6
17-15I-14MP-0300-4	3	1.718	17-15I-14MP-0300-6
17-15I-14MP-0400-4	4	1.968	17-15I-14MP-0400-6

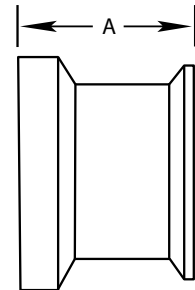

17-15I-15

Female I-Line x Threaded Bevel Seat Adapter

304 Item Number	Tube O.D.	A	316L Item Number
17-15I-15-0100-4	1	1.562	17-15I-15-0100-6
17-15I-15-0150-4	1.5	1.655	17-15I-15-0150-6
17-15I-15-0200-4	2	1.749	17-15I-15-0200-6
17-15I-15-0250-4	2.5	1.999	17-15I-15-0250-6
17-15I-15-0300-4	3	2.124	17-15I-15-0300-6
17-15I-15-0400-4	4	2.375	17-15I-15-0400-6

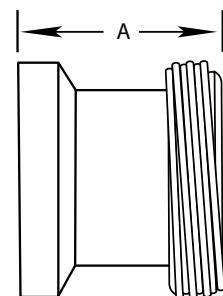

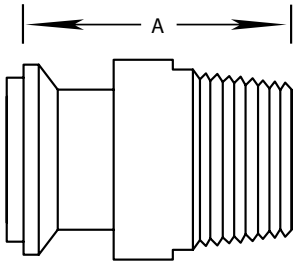

21FI-14I

Male I-Line x Male NPT Adapter

304 Item Number	Tube O.D.	A	316L Item Number
21FI-14I-0100-4	1 in	2.343	21FI-14I-0100-6
21FI-14I-0150-4	1.5 in	2.500	21FI-14I-0150-6
21FI-14I-0200-4	2 in	2.593	21FI-14I-0200-6
21FI-14I-0250-4	2.5 in	3.125	21FI-14I-0250-6
21FI-14I-0300-4	3 in	3.406	21FI-14I-0300-6
21FI-14I-0400-4	4 in	3.593	21FI-14I-0400-6

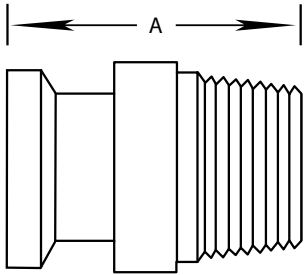

21FI-15I

Female I-Line x Male NPT Adapter

304 Item Number	Tube O.D.	A	316L Item Number
21FI-15I-0100-4	1 in	2.531	21FI-15I-0100-6
21FI-15I-0150-4	1.5 in	2.687	21FI-15I-0150-6
21FI-15I-0200-4	2 in	2.843	21FI-15I-0200-6
21FI-15I-0250-4	2.5 in	3.437	21FI-15I-0250-6
21FI-15I-0300-4	3 in	3.718	21FI-15I-0300-6
21FI-15I-0400-4	4 in	3.906	21FI-15I-0400-6

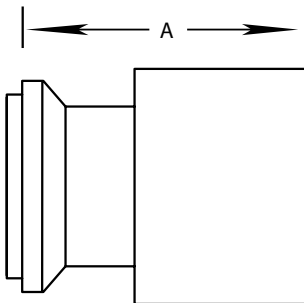

22FI-14I

Male I-Line x Female NPT Adapter

304 Item Number	Tube O.D.	A	316L Item Number
22FI-14I-0100-4	1 in	1.687	22FI-14I-0100-6
22FI-14I-0150-4	1.5 in	2.187	22FI-14I-0150-6
22FI-14I-0200-4	2 in	2.218	22FI-14I-0200-6
22FI-14I-0250-4	2.5 in	2.437	22FI-14I-0250-6
22FI-14I-0300-4	3 in	2.718	22FI-14I-0300-6
22FI-14I-0400-4	4 in	3.031	22FI-14I-0400-6

22FI-15I

Female I-Line x Female NPT Adapter

304 Item Number	Tube O.D.	A	316L Item Number
22FI-15I-0100-4	1 in	1.906	22FI-15I-0100-6
22FI-15I-0150-4	1.5 in	2.375	22FI-15I-0150-6
22FI-15I-0200-4	2 in	2.468	22FI-15I-0200-6
22FI-15I-0250-4	2.5 in	2.781	22FI-15I-0250-6
22FI-15I-0300-4	3 in	3.031	22FI-15I-0300-6
22FI-15I-0400-4	4 in	3.343	22FI-15I-0400-6

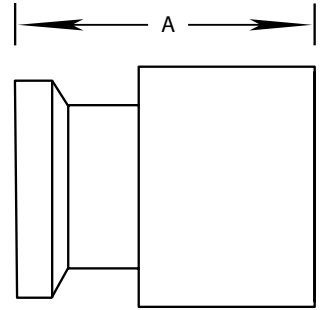

3114I14I

Male I-Line Concentric Reducer

304 Item Number	Tube O.D.	A	316L Item Number
3114I14I-0150X0100-4	1.5 x 1	3.343	3114I14I-0150X0100-6
3114I14I-0200X0100-4	2 x 1	5.375	3114I14I-0200X0100-6
3114I14I-0200X0150-4	2 x 1.5	3.500	3114I14I-0200X0150-6
3114I14I-0250X0150-4	2.5 x 1.5	5.930	3114I14I-0250X0150-6
3114I14I-0250X0200-4	2.5 x 2	3.562	3114I14I-0250X0200-6
3114I14I-0300X0150-4	3 x 1.5	7.656	3114I14I-0300X0150-6
3114I14I-0300X0200-4	3 x 2	5.625	3114I14I-0300X0200-6
3114I14I-0300X0250-4	3 x 2.5	3.750	3114I14I-0300X0250-6
3114I14I-0400X0200-4	4 x 2	9.812	3114I14I-0400X0200-6
3114I14I-0400X0250-4	4 x 2.5	7.875	3114I14I-0400X0250-6
3114I14I-0400X0300-4	4 x 3	5.937	3114I14I-0400X0300-6

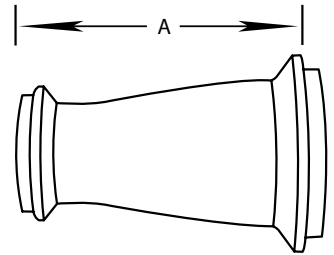

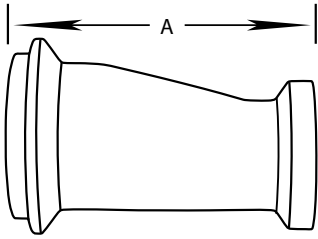
**31141151****Male I-Line x Female I-Line Concentric Reducer**

304 Item Number	Tube O.D.	A	316L Item Number
31141151-0150X0100-4	1.5 x 1	3.531	31141151-0150X0100-6
31141151-0200X0100-4	2 x 1	5.562	31141151-0200X0100-6
31141151-0200X0150-4	2 x 1.5	3.718	31141151-0200X0150-6
31141151-0250X0150-4	2.5 x 1.5	5.781	31141151-0250X0150-6
31141151-0250X0200-4	2.5 x 2	3.874	31141151-0250X0200-6
31141151-0300X0150-4	3 x 1.5	7.843	31141151-0300X0150-6
31141151-0300X0200-4	3 x 2	5.937	31141151-0300X0200-6
31141151-0300X0250-4	3 x 2.5	4.062	31141151-0300X0250-6
31141151-0400X0200-4	4 x 2	10.062	31141151-0400X0200-6
31141151-0400X0250-4	4 x 2.5	8.187	31141151-0400X0250-6
31141151-0400X0300-4	4 x 3	6.250	31141151-0400X0300-6

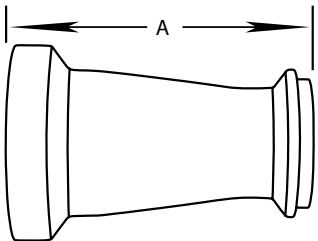
**31151141****Female I-Line x Male I-Line Concentric Reducer**

304 Item Number	Tube O.D.	A	316L Item Number
31151141-0150X0100-4	1.5 x 1	5.310	31151141-0150X0100-6
31151141-0200X0100-4	2 x 1	5.625	31151141-0200X0100-6
31151141-0200X0150-4	2 x 1.5	3.781	31151141-0200X0150-6
31151141-0250X0150-4	2.5 x 1.5	5.906	31151141-0250X0150-6
31151141-0250X0200-4	2.5 x 2	3.937	31151141-0250X0200-6
31151141-0300X0150-4	3 x 1.5	7.968	31151141-0300X0150-6
31151141-0300X0200-4	3 x 2	6.000	31151141-0300X0200-6
31151141-0300X0250-4	3 x 2.5	4.062	31151141-0300X0250-6
31151141-0400X0200-4	4 x 2	10.125	31151141-0400X0200-6
31151141-0400X0250-4	4 x 2.5	8.187	31151141-0400X0250-6
31151141-0400X0300-4	4 x 3	6.250	31151141-0400X0300-6

31151151

Female I-Line Concentric Reducer

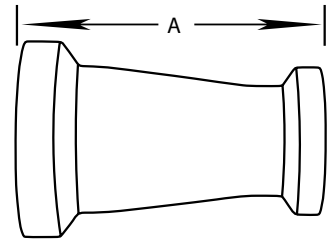

304 Item Number	Tube O.D.	A	316L Item Number
31151151-0150X0100-4	1.5 x 1	3.718	31151151-0150X0100-6
31151151-0200X0100-4	2 x 1	5.812	31151151-0200X0100-6
31151151-0200X0150-4	2 x 1.5	3.968	31151151-0200X0150-6
31151151-0250X0150-4	2.5 x 1.5	6.093	31151151-0250X0150-6
31151151-0250X0200-4	2.5 x 2	4.187	31151151-0250X0200-6
31151151-0300X0150-4	3 x 1.5	8.156	31151151-0300X0150-6
31151151-0300X0200-4	3 x 2	6.250	31151151-0300X0200-6
31151151-0300X0250-4	3 x 2.5	4.375	31151151-0300X0250-6
31151151-0400X0200-4	4 x 2	10.375	31151151-0400X0200-6
31151151-0400X0250-4	4 x 2.5	8.500	31151151-0400X0250-6
31151151-0400X0300-4	4 x 3	6.562	31151151-0400X0300-6

32141141

Male I-Line Eccentric Reducer

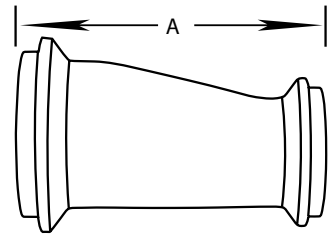

304 Item Number	Tube O.D.	A	316L Item Number
32141141-0150X0100-4	1.5 x 1	3.343	32141141-0150X0100-6
32141141-0200X0100-4	2 x 1	5.375	32141141-0200X0100-6
32141141-0200X0150-4	2 x 1.5	3.500	32141141-0200X0150-6
32141141-0250X0150-4	2.5 x 1.5	5.593	32141141-0250X0150-6
32141141-0250X0200-4	2.5 x 2	3.562	32141141-0250X0200-6
32141141-0300X0150-4	3 x 1.5	7.656	32141141-0300X0150-6
32141141-0300X0200-4	3 x 2	5.625	32141141-0300X0200-6
32141141-0300X0250-4	3 x 2.5	3.749	32141141-0300X0250-6
32141141-0400X0200-4	4 x 2	9.812	32141141-0400X0200-6
32141141-0400X0250-4	4 x 2.5	7.874	32141141-0400X0250-6
32141141-0400X0300-4	4 x 3	5.937	32141141-0400X0300-6

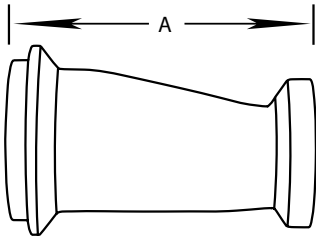

32141151

Male I-Line x Female I-Line Eccentric Reducer

304 Item Number	Tube O.D.	A	316L Item Number
32141151-0150X0100-4	1.5 x 1	3.531	32141151-0150X0100-6
32141151-0200X0100-4	2 x 1	5.562	32141151-0200X0100-6
32141151-0200X0150-4	2 x 1.5	3.718	32141151-0200X0150-6
32141151-0250X0150-4	2.5 x 1.5	5.780	32141151-0250X0150-6
32141151-0250X0200-4	2.5 x 2	4.875	32141151-0250X0200-6
32141151-0300X0150-4	3 x 1.5	7.843	32141151-0300X0150-6
32141151-0300X0200-4	3 x 2	5.937	32141151-0300X0200-6
32141151-0300X0250-4	3 x 2.5	4.062	32141151-0300X0250-6
32141151-0400X0200-4	4 x 2	10.062	32141151-0400X0200-6
32141151-0400X0250-4	4 x 2.5	8.187	32141151-0400X0250-6
32141151-0400X0300-4	4 x 3	6.249	32141151-0400X0300-6

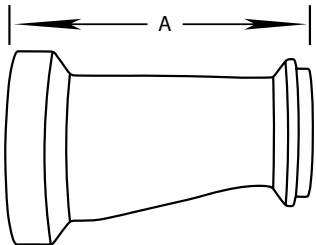

32151141

Female I-Line x Male I-Line Eccentric Reducer

304 Item Number	Tube O.D.	A	316L Item Number
32151141-0150X0100-4	1.5 x 1	3.530	32151141-0150X0100-6
32151141-0200X0100-4	2 x 1	5.624	32151141-0200X0100-6
32151141-0200X0150-4	2 x 1.5	3.781	32151141-0200X0150-6
32151141-0250X0150-4	2.5 x 1.5	5.906	32151141-0250X0150-6
32151141-0250X0200-4	2.5 x 2	3.937	32151141-0250X0200-6
32151141-0300X0150-4	3 x 1.5	7.968	32151141-0300X0150-6
32151141-0300X0200-4	3 x 2	6.000	32151141-0300X0200-6
32151141-0300X0250-4	3 x 2.5	4.061	32151141-0300X0250-6
32151141-0400X0200-4	4 x 2	10.124	32151141-0400X0200-6
32151141-0400X0250-4	4 x 2.5	8.187	32151141-0400X0250-6
32151141-0400X0300-4	4 x 3	6.250	32151141-0400X0300-6

32151151

Female I-Line Eccentric Reducer

304 Item Number	Tube O.D.	A	316L Item Number
32151151-0150X0100-4	1.5 x 1	3.718	32151151-0150X0100-6
32151151-0200X0100-4	2 x 1	5.812	32151151-0200X0100-6
32151151-0200X0150-4	2 x 1.5	3.968	32151151-0200X0150-6
32151151-0250X0150-4	2.5 x 1.5	6.093	32151151-0250X0150-6
32151151-0250X0200-4	2.5 x 2	4.187	32151151-0250X0200-6
32151151-0300X0150-4	3 x 1.5	8.155	32151151-0300X0150-6
32151151-0300X0200-4	3 x 2	6.249	32151151-0300X0200-6
32151151-0300X0250-4	3 x 2.5	4.374	32151151-0300X0250-6
32151151-0400X0200-4	4 x 2	10.374	32151151-0400X0200-6
32151151-0400X0250-4	4 x 2.5	8.499	32151151-0400X0250-6
32151151-0400X0300-4	4 x 3	6.561	32151151-0400X0300-6

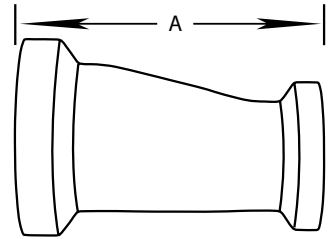

28AI

Female I-Line Lateral "Y"

304 Item Number	Tube O.D.	A	B	316L Item Number
28AI-0100-7-4	1	7.562	5.781	28AI-0100-7-6
28AI-0150-7-4	1.5	9.250	7.125	28AI-0150-7-6
28AI-0200-7-4	2	10.687	8.156	28AI-0200-7-6
28AI-0250-7-4	2.5	12.437	9.656	28AI-0250-7-6
28AI-0300-7-4	3	13.187	10.093	28AI-0300-7-6
28AI-0400-7-4	4	15.500	12.093	28AI-0400-7-6

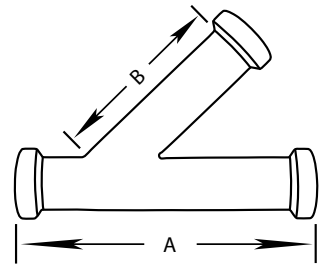

28BI

Female I-Line True "Y"

304 Item Number	Tube O.D.	A	B	316L Item Number
28BI-0100-7-4	1	2.781		28BI-0100-7-6
28BI-0150-7-4	1.5	2.937		28BI-0150-7-6
28BI-0200-7-4	2	3.656		28BI-0200-7-6
28BI-0250-7-4	2.5	4.526		28BI-0250-7-6
28BI-0300-7-4	3	5.218		28BI-0300-7-6
28BI-0400-7-4	4	6.718		28BI-0400-7-6

